

BOSTO

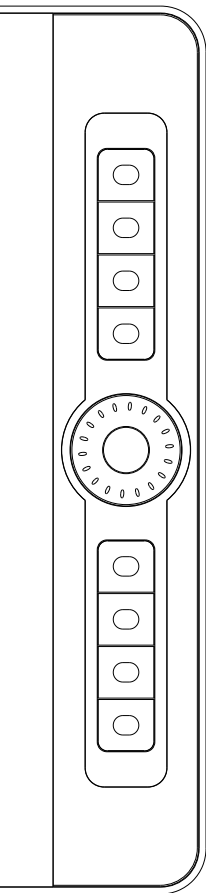

BOSTO
X5 Pro (Series)
Studio 16HD

快速使用指南 1
Quick Guide 7

クイックガイド 13
제품 퀵 가이드 19

产品简介

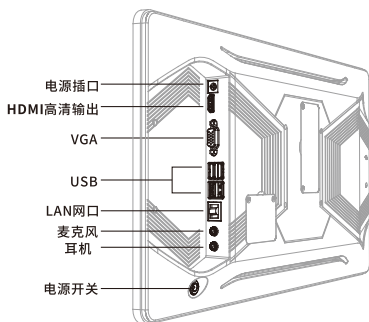
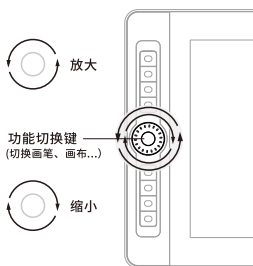
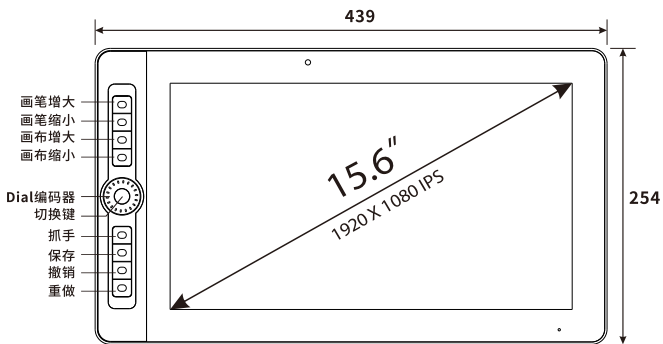

配件



压感笔



笔尖

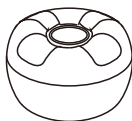

笔座



手套



可调支架

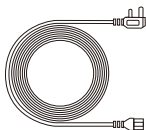

电源线

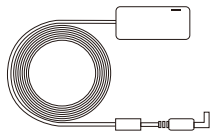

适配器



使用指南



驱动U盘

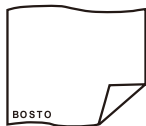

清洁布



产品保护罩

屏幕校准

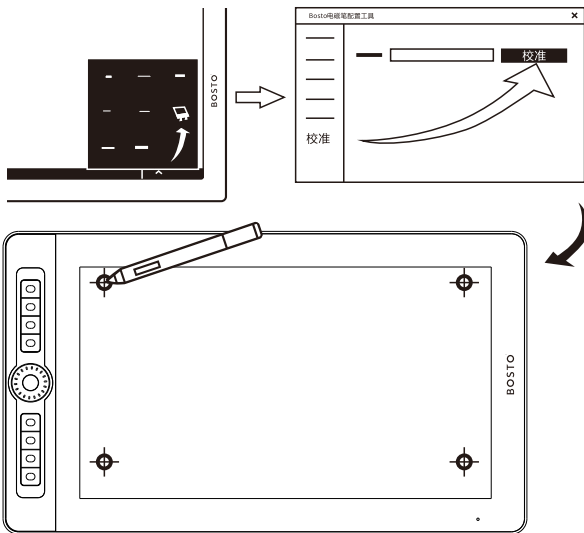

触摸设置

(只限有触摸型号)

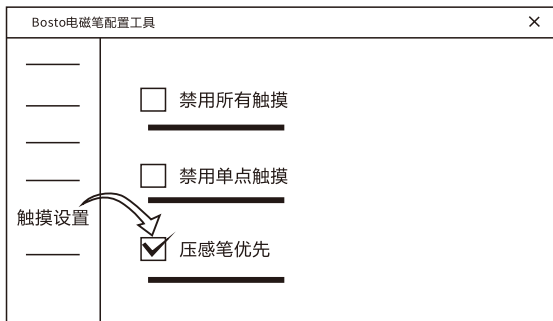

按键设定

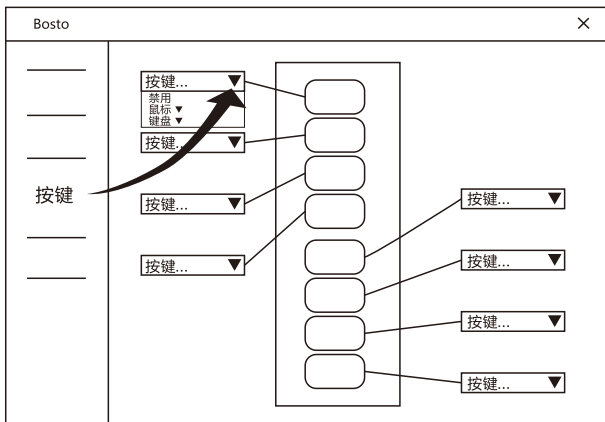

设置为鼠标：点击“按键”找到“鼠标”选择鼠标属性，完成按键鼠标设置。

设置为键盘按键：点击“按键”，弹出对话框如果设定为“撤销”或“重做”，直接点击选择完成按键设置。如果没有需要，请选择“按键..”按以下的方法完成。

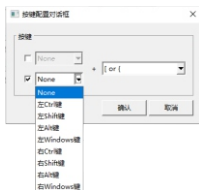

设置组合按键：在左边方框“√”点上，单击展开，找到想要的按键；在右边对话框选择下一个按键。点击确认，完成组合键设置。

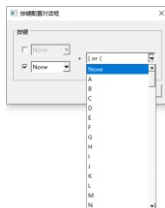

设置单个键盘按键：点击右边对话框，展出字母或符合，选对应的字母或符合，点击确认完成按键设置。

压感笔设置

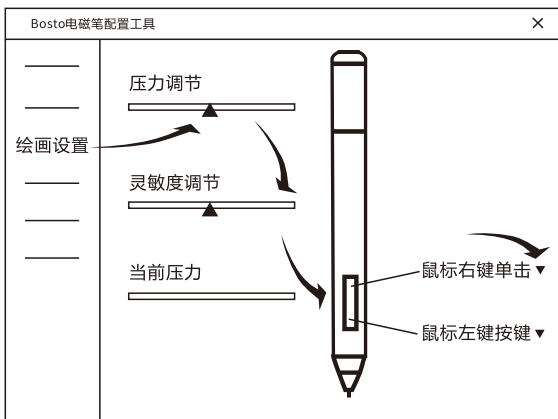

更换笔尖

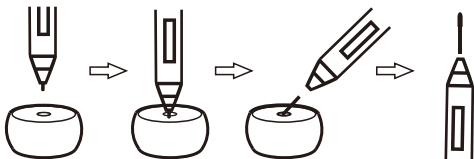

规格参数

产品型号	X5 Pro(BST-X9)	无线链接	Wi-Fi IEEE 802.11 ac Bluetooth 5.0
屏幕尺寸	15.6英寸	额定电压	12V
屏幕操作	支持笔控/支持多点触控	额定功率	60W
屏幕分辨率	1920*1080 (16:9)	输出接口	DC电源接口/HDMI/VGA/ USB3.0*2/USB2.0*2/ 网线接口/3.5mm音频接口
外观尺寸	439X254X12MM(39MM)	重量	2.3kg
工作区域	345X195MM	笔感应技术	被动式电磁感应 (无源)
液晶模式	IPS全视角显示屏	手写分辨率	5080 LPI
显示颜色	1670万色	读取速度	266点/秒
处理器	Intel i7-6500U/3865U/...	压感级别	8192
系统内存	4GB/8GB	倾角识别	±60°
存储空间	SSD:125GB/256GB/...	感应高度	10mm
按键	八个自定义按键+编码器	精确度	±0.3mm
支架尺寸	21cm*30cm		
支架重量	0.4kg		
支架调角度	20°-80°		
操作系统	Windows 10/...		
应用领域	手绘插画、设计、动漫游戏、 手写签批、网络教育		

售后服务

如有产品使用 或设置等常见问题	在 HTTP://bostotablet.com/Support/Driver 查看 或发送邮件至 service@bostotablet.com 咨询
驱动更新下载	HTTP://bostotablet.com/Support/Driver

PRODUCT DESCRIPTION

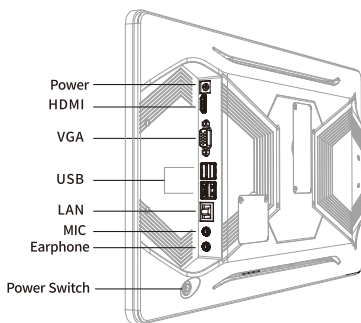
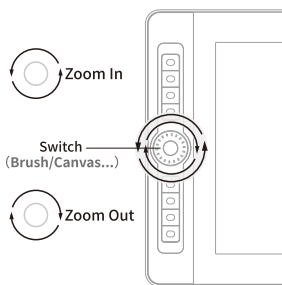
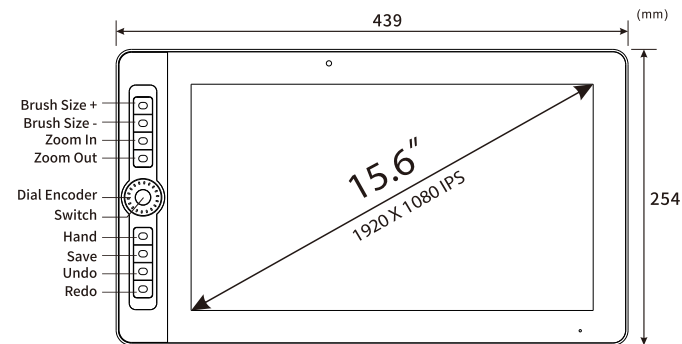

ACCESSORIES



Battery-free
Stylus



Nib



Pen Holder



Drawing Glove



Adjustable Stand

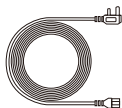

Power Cord

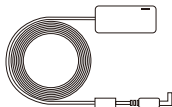

Power Adapter



Quick Guide



USB Driver



Cleaning Cloth



Tablet Protective
Cover

SCREEN CALIBRATION

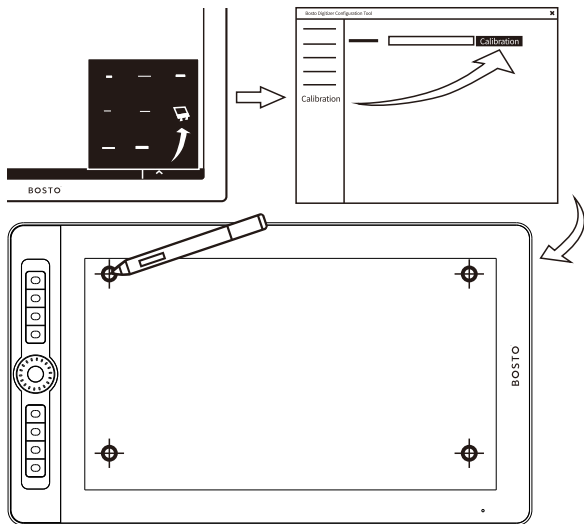

TOUCH SETTINGS

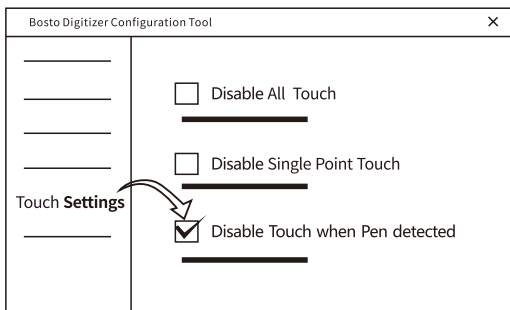

EXPRESS KEY SETTINGS

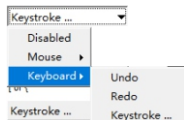
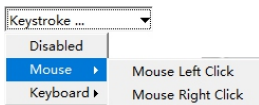
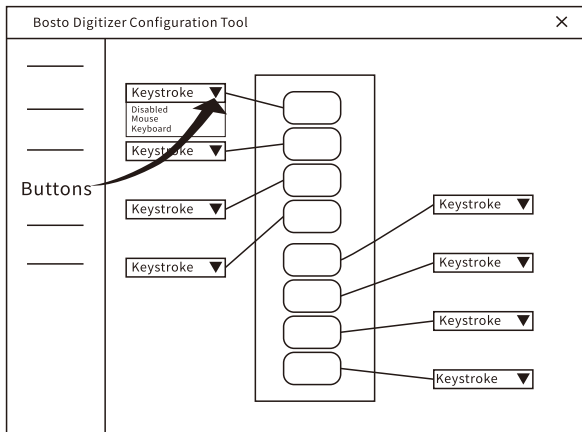

Option one: set to mouse function.

Option two: set to combination key function.

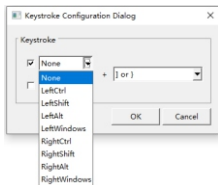

Steps: down the page and select the key you want and click on ok.

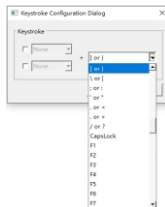

Option three: set to single key function.

PRESSURE PEN SETTINGS

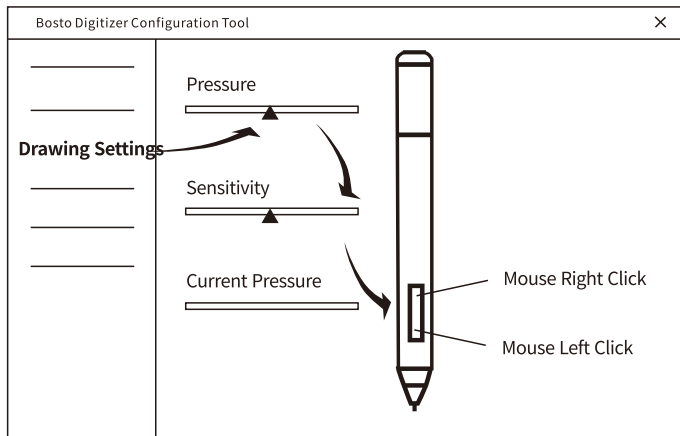

REPLACE PEN NIB

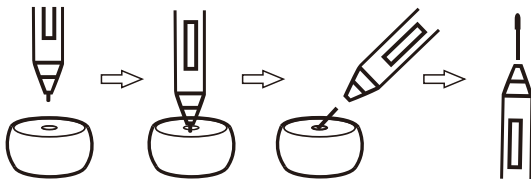

PRODUCTION SPECIFICATION

Product Type	X5 Pro(BST-X9)	Wireless Connections	Wi-Fi IEEE 802.11 ac Bluetooth 5.0
Size	15.6Inch	Rated Voltage	12V
Screen Touch	Pen Touch/Multi Touch	Rated Power	60W
Screen Resolution	1920*1080 (16:9)	Output Interface	DC power interface/HDMI/ VGA/USB3.0*2/USB2.0*2/ Network Interface/3.5mm Audio Interface
Product Dimension	439X254X12MM(39MM)	Net Weight	2.3kg
Active Area	345X195MM	Pen Technology	Passive Electromagnetic Induction
LCD Mode	IPS Full Viewing Angle Display	Pen Resolution	5080 LPI
Color Value	1670M	Reading Speed	266reports per second
Processor	Intel i7-6500U/3865U/...	Pen Pressure	8192
System Memory	4GB/8GB	Tilt Recognition	±60°
Storage	SSD:125GB/256GB/...	Induction Height	10mm
Buttons	8 Custom Keys	Accuracy	±0.3mm
Stand Size	21cm*30cm		
Stand Weight	0.4kg		
Stand Angle	20°-80°		
System	Windows 10/...		
Applicable Field	Sketch,design,animation and game design,signature, remote teaching.		

AFTER-SALES SERVICE

If there are common problems such as product use or settings	View at http://bostotablet.com/Support/Driver or send an email to service@bostotablet.com for consultation
Driver update download	HTTP://bostotablet.com/Support/Driver

製品説明

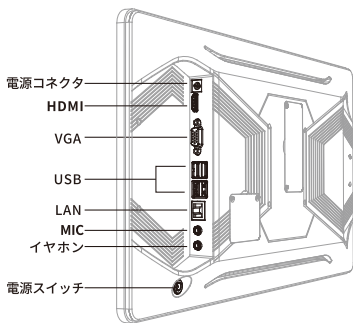
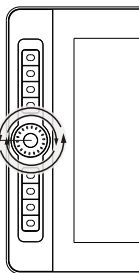
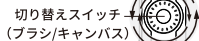
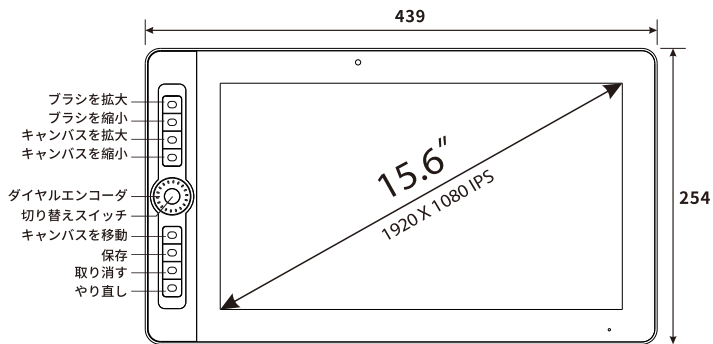

JP

付属品一覧



スタイラスペン



替え芯



ペン立て



二本指グローブ



スタンド

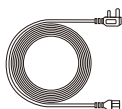

電源ケーブル

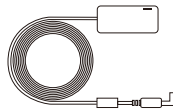

電源アダプタ



取扱説明書



USBメモリ
(ドライバ内蔵)



クリーニング
グクロス



保護カバー

スクリーンキャリブレーション

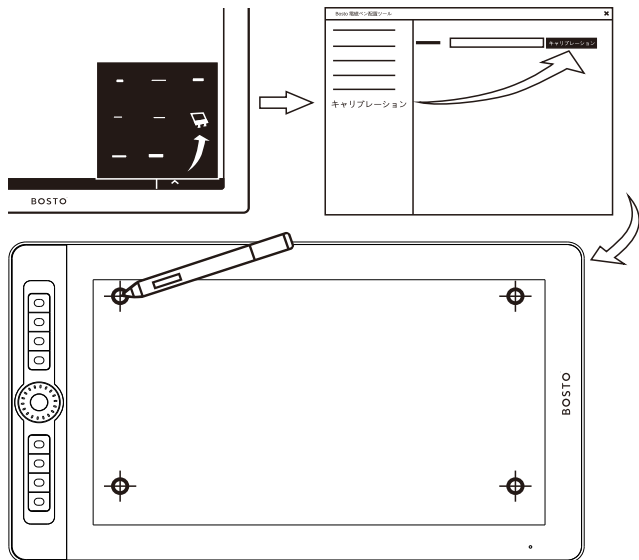

JP

タッチ設定

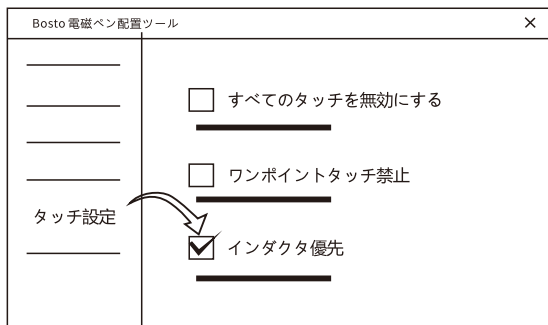

ショートカットキーの設定

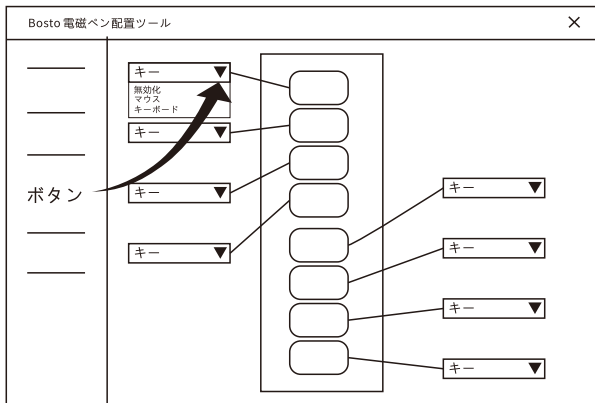

マウスとして機能される：キーの項目内にマウス左クリック、右クリックなど設定可能

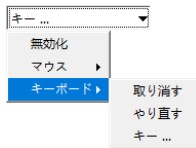

キーボードとして機能される：「取り消す」、「やり直す」の他には下記の図のように設定できる

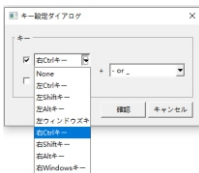

コンボキー：左のチェックを入れておいて好みの組み合わせをセッティングすることができる



シングルキー：単一のキーを利用したい場合、左のチェックを入れないようにして右にはアルファベットまたは符号を選べます。

ペンの設定

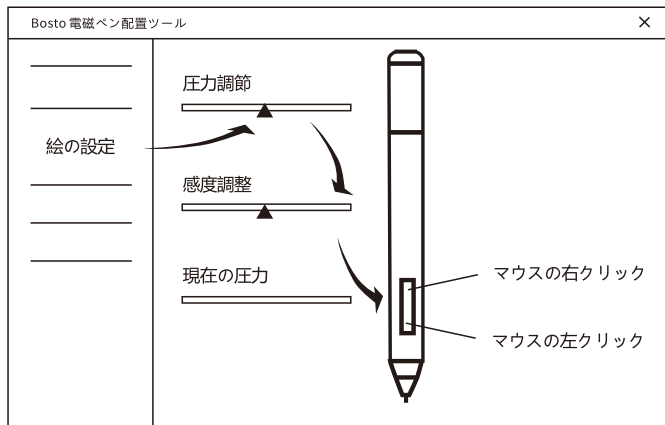

JP

ペン先を交換する

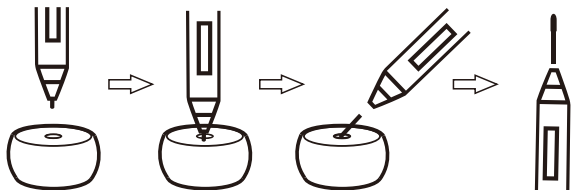

製品スペック

型番	X5 Pro(BST-X9)	ワイヤレス接続	Wi-Fi IEEE 802.11 ac Bluetooth 5.0
画面寸法	15.6インチ	定格電圧	12V
画面操作	ペン制御、手動制御、マルチタッチをサポートします。	定格出力	60W
画面の解像度	1920*1080 (16:9)	出カインターフェース	DC電源インターフェース/HDMI/VGA/USB /ネットワークケーブルインターフェース /3.5mmオーディオインターフェース /マイクインターフェース付き
製品サイズ	439X254X12MM(39MM)	重量	2.3kg
動作範囲	345X195MM	スタンドサイズ	21cm*30cm
パネルタイプ	IPS全視野角ディスプレイ	スタンドの重さ	0.4kg
表示色	1670万色	調整可能範囲	20°-80°
CPUプロセッサ	Intel i7-6500U/3865U/...	対応しているOS	Windows 10/...
システムメモリ	4GB/8GB	応用分野	手描きのイラスト、デザイン、 アニメーションゲーム、手書き の署名、オンライン教育
ストレージ	SSD:125GB/256GB/...		
ボタン	8個ショットカットキー +ダイヤル		

JP

読み取り方式	受動式電磁誘導(パッシブ)
解像度	5080 LPI
報告率	266PPS/S
圧カレベル	8192
傾き検知	±60°
読み取り高度	10mm
正確率	±0.3mm

アフターサービス

製品使用においての問題	HTTP://bostotablet.com/Support/Driver で szbosto@126.com にメールを確認または送信して 問い合わせします。
ドライバのDL、更新等	HTTP://bostotablet.com/Support/Driver

제품 개요

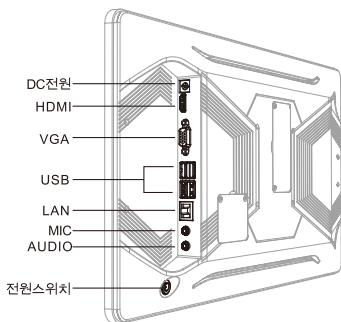
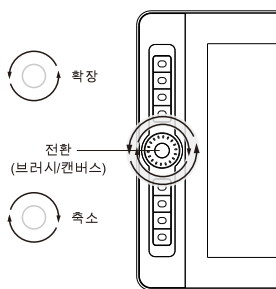
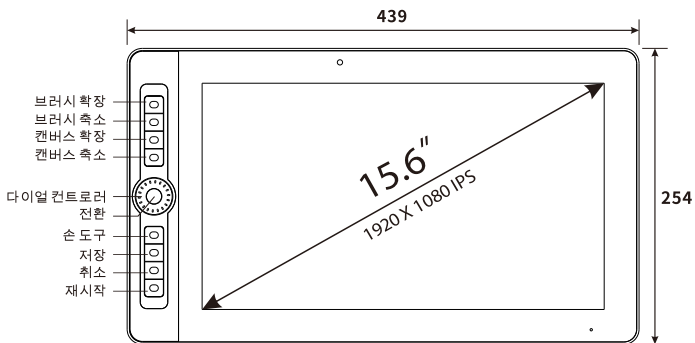



Bosto Pro Pen



교체용 펜심



펜 꽃이



마찰 방지용 장갑



스탠드

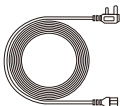

전원 코드

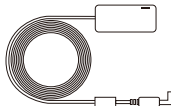

AC전원 어댑터



제품 가이드



USB



클리닝 천



보호커버

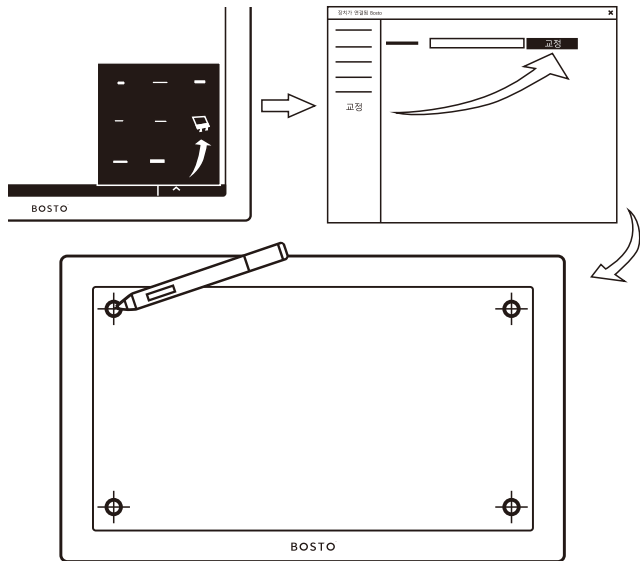

터치 설정

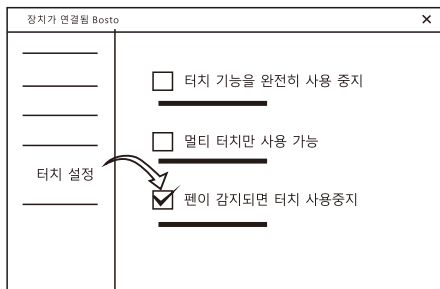

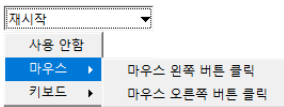
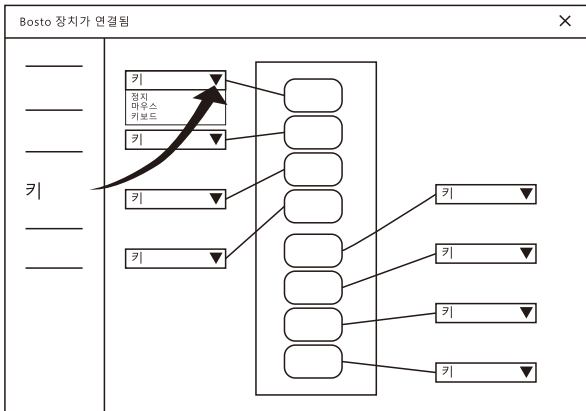

1. 마우스 모드 설정: "키"를 클릭하고 "마우스"를 선택하면 마우스 모드를 설정완료

2. 키보드 모드 설정: "키"를 클릭하고 "키보드"를 클릭하고 "취소"나 "재시작"을 선택하고 "취소"나 "재시작"기능이 필요없는 경우 "버튼..."을 선택됨

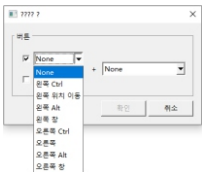

3. 컴포지션 설정: 왼쪽의 "√"를 클릭하고 원하는 조합버튼을 세팅할 수 있음

4. 단일키 설정: 단일키를 이용하고 싶은 경우, 오른쪽의 "√"를 클릭하고 원하는 알파벳이나 부호를 선택됨

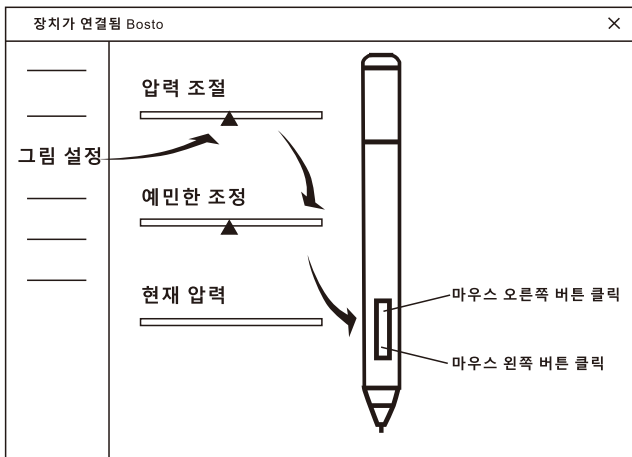

펜심 교체

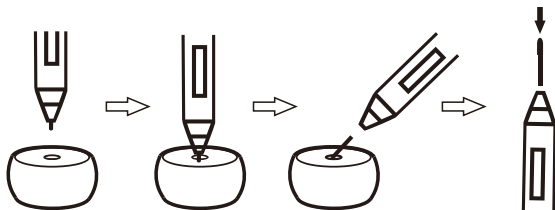

제품스펙

제품 모델	X5 Pro(BST-X9)	무선연결	Wi-Fi IEEE 802.11 ac Bluetooth 5.0
화면 크기	15.6인치	정격 전압	12V
화면조작	펜터치/멀티터치 지원	정격 출력	60W
화면 해상도	1920*1080 (16:9)	입력 인터페이스	DC전원 커넥터/HDMI/VGA/ USB3.0x2/USB2.0x2/인터넷 커넥터/3.5mm오디오 인터페이스
제품 크기	439X254X12MM(39MM)	무게	5kg
작업구역	345X195MM	필감응기술	전자기 유도 (배터리 프리)
액정모드	IPS디스플레이	펜 해상도	5080 LPI
색농도	16.7M	보고율	266PPS
프로세서	Intel i7-6500U/3865U/...	압력감도	8192레벨
DDR메모리	4GB/8GB	기울기 감지	±60°
저장공간	SSD:125GB/256GB/...	높이감지	10mm
단축키	사용자 정의 단축키8세 + 다이얼 컨트롤러	정확도	±0.3mm
스탠드 크기	21cm*30cm		
스탠드 무게	0.4kg		
스탠드 조절가능각도	20°-80°		
운영체제	Windows 10/...		
응용분야	일러스트,디자인, 애니메이션 게임, 손글씨 작성, 온라인강의		

AS안내.

사용문제나 설정문제 문의	HTTP://bostotablet.com/Support/Driver 에 문제 검색하거나 service@bostotablet.com 에 메일로 보내시기 바랍니다
드라이버 업그레이드 다운로드	HTTP://bostotablet.com/Support/Driver



Bosto FB



BOSTO



YouTube



Instagram



Twitter

BOSTO

If you have any questions,
please feel free to contact us through:
service@bostotablet.com
www.bostotablet.com

深圳市博学通科技有限公司

全国服务热线: 0755-29691514

邮箱: Fanly@bostotablet.com

QQ: 2402578413

网站: www.bostotablet.com

生产地址: 广东省东莞市长安镇上沙安力科技园B6栋北门4楼

邮编: 523859

